

SWEETWATER STEEL

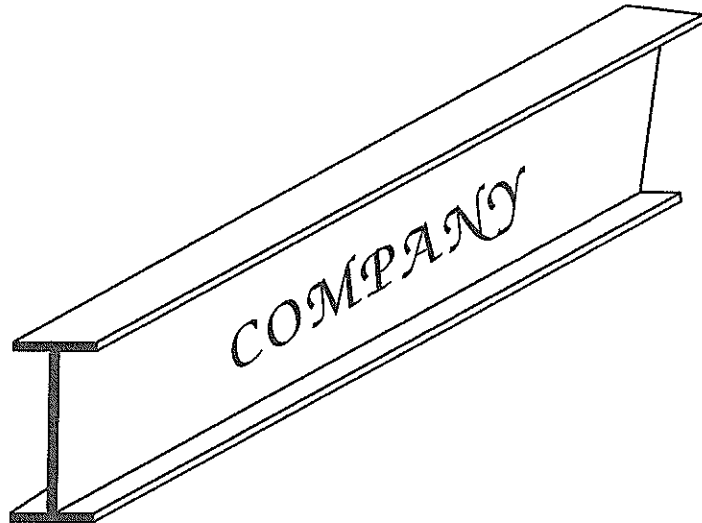

Metal Building Products October 2015

Two Locations to Serve Your Needs

www.sweetwatersteel.net

* BRANCH LOCATION *

Sweetwater Steel Company
10416 N. I-20
Sweetwater, TX 79556
(Located 4 miles west of Sweetwater)
(Exit Mile Marker 240)

Phone: 325-235-3644
Toll Free: 800-982-3384
Fax: 325-235-3935

Store Hours

7:30 a.m. - 5:00 p.m. Mon. - Fri.
7:30 a.m. - 11:30 a.m. Sat.

Sweetwater Steel Company
1047 Early Blvd.
Early, TX 76802
(Located Downtown Early on Hwy 67/377)

Phone: 325-641-1345
Toll Free: 877-741-1345
Fax: 325-641-2834

• Metal Building Products • Structural Steel • Fencing Supplies •

ALL PRICES IN THIS CATALOGUE SUBJECT TO CHANGE WITHOUT NOTICE

Sweetwater Steel Co. Policies

Return Material Policy

There will be a 30% restocking charge on all metal roofing, siding and trim products. There will be a 10% restocking charge on all other material. On all refunds, the material must be returned in original condition and accompanied with a sales receipt within 45 days of the date of purchase. The condition of the material returned will be determined by Sweetwater Steel Company.

Stocking & Pricing Policy

Some products listed in the catalogue are not kept in stock at all times. Due to market fluctuations, prices are subject to change without notice. Please call to verify pricing and availability. If you have an inquiry on products not listed, please call. If they are not in stock, we would like to special order them for you.

Warranty Policy

Customers are responsible for providing a copy of the sales invoice on all warranty claims.

Delivery Service

Sweetwater Steel Company offers a delivery service to its customers. Please call for pricing.

Storage Policy

All orders on stock products must be picked up, or arrangements made for delivery, within ten (10) work days from the date of order. After this time the material will be placed back into stock. To request extension, notify your sales representative.

Special Order Policy

A 25% deposit will be required on most special order products.

Residential / Commercial / Industrial Panel Profile Selections

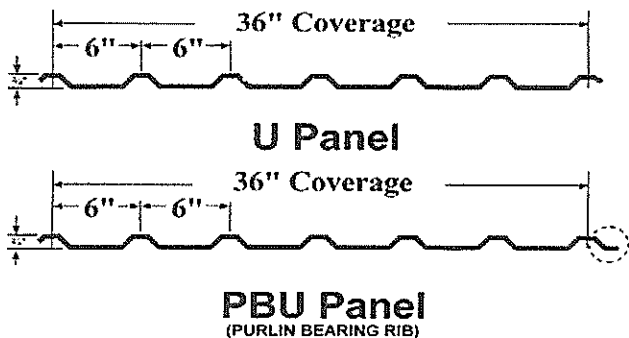
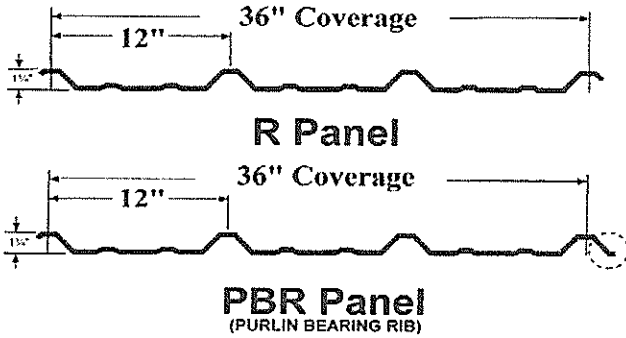

Premium 40 and 35 Year Limited Warranty PBR or PBU Material

(Wide color selection, custom orders only.)

All Sheets are Priced per 100 Square Feet

40 yr. Limited Warranty	SMP 26 ga.	80,000 p.s.i.	Ash Gray, Light Stone, Polar White, Sahara Tan	\$73.95 sq.
40 yr. Limited Warranty	SMP 26 ga.	80,000 p.s.i.	Aztec Gold, Burnish Slate, Charcoal Gray, Colony Green	
			Desert Beige, Kelly Green, Rustic Red	\$75.95 sq.
40 yr. Limited Warranty	SMP 26 ga.	80,000 p.s.i.	Hawaiian Blue, & Koko Brown	\$76.95 sq.
40 yr. Limited Warranty	SMP 26 ga.	80,000 p.s.i.	Burgundy, Fern Green Harbor Blue, Orange	\$82.95 sq.
			Stealth Black	
40 yr. Limited Warranty	SMP 26 ga.	80,000 p.s.i.	Crimson Red	\$84.95 sq.
35 yr. Limited Warranty	Trinar 26 ga.	80,000 p.s.i.	Kelly Green	\$97.95 sq.
35 yr. Limited Warranty	Trinar 26 ga.	80,000 p.s.i.	Copper Metallic, & Deep Blue	\$104.95 sq.
30 yr. Limited Warranty	SMP 26 ga.	80,000 p.s.i.	Ash Gray, Desert Beige, Light Stone, (RPN or UPN)	\$69.95 sq.
			Polar White & Sahara Tan	
30 yr. Limited Warranty	SMP 26 ga.	80,000 p.s.i.	Burnish Slate, Charcoal Gray (RPN or UPN)	\$71.50 sq.
30 yr. Limited Warranty	SMP 26 ga.	80,000 p.s.i.	Crimson Red, Fern Green, Kelly Green (RPN or UPN)	\$72.95 sq.
			Koko Brown, Rustic Red	
25 yr. Limited Warranty	26 ga.	80,000 p.s.i.	Galvalume Plus (PBR or PBU)	\$55.95 sq.
25 yr. Limited Warranty	29 ga.	80,000 p.s.i.	Galvalume Plus (RPN or UPN)	\$44.95 sq.

Energy Star Certification available on selected colors. Please inquire if interested.

UL 2218 Class 4 Impact Resistance Certification available, but must be requested at the time of order.
The cost for this is \$.75 per sheet.

Quality RPN or UPN (10 & 5 Year) Material

All Sheets are Priced per 100 Square Feet

10 yr. Limited Warranty	26 ga.	80,000 p.s.i.	Light Stone, Polar White, Sahara Tan (stock colors)	\$65.95 sq.
			Ash Gray, (custom orders only)	
5 yr. Limited Warranty	26 ga.	80,000 p.s.i.	Mossy Oak Bottomland Camouflage	\$108.95 sq.
5 yr. Limited Warranty	26 ga.	80,000 p.s.i.	Galvalume Plus (custom orders only)	\$51.95 sq.
Perforated	26 ga.	80,000 p.s.i.	White (stock or custom orders)	\$94.95 sq.

Secondary Material

Non-Warranty	26 ga.	#2 Painted	(stock or custom orders)	\$59.95 sq.
Non-Warranty	26 ga.	#2 Galvalume	(stock or custom orders)	\$49.95 sq.

Bargain Material

Non-Warranty	26 ga.	#3 Galvalume/Galvanized	(stock only)	\$38.95 sq.
Non-Warranty	26 ga.	#3 Mixed Colors	(stock only)	\$36.95 sq.
Non-Warranty	26 ga.	#3 Painted	(stock only limited colors)	\$41.95 sq.

We have a variety of different profiles, gauges & colors available. Please inquire for stock sizes of quality grade material and availability of stock in secondary and bargain materials, if we don't have the product in stock we would like to order it for you.

Note: **Secondary material and bargain materials** will have some type of cosmetic defect, out of square, paint cracking, paint blisters, oil canning, edge wave, water stain or a pie crust edge. The quality will sometimes vary, and does not have a warranty.

Prices subject to change without notice

Structural Steel

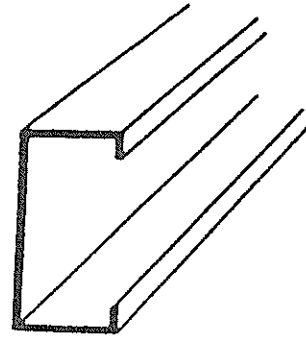
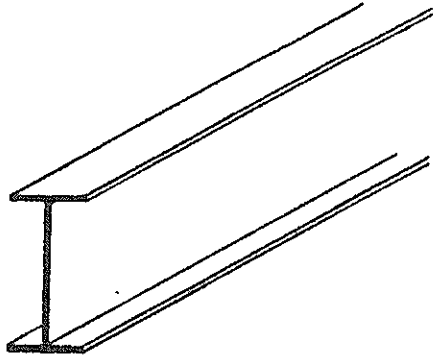

#1 Wide Flange Beam

6" X 4" X 9#	\$44.50 CWT.
6" X 6" X 15#	\$44.50 CWT.
8" X 4" X 10#	\$44.50 CWT.
8" X 4" X 15#	\$44.50 CWT.
8" X 5 1/4" X 18#	\$44.50 CWT.
10" X 4" X 12#	\$44.50 CWT.
10" X 4" X 17#	\$44.50 CWT.
12" X 4" X 14#	\$44.50 CWT.
12" X 4" X 16#	\$44.50 CWT.
12" X 4" X 19#	\$44.50 CWT.
14" X 5" X 22#	\$44.50 CWT.
16" X 5 1/2" X 26#	\$44.50 CWT.
18" X 6" X 35#	\$44.50 CWT.
21" X 6 1/2" X 44#	\$46.50 CWT.

#1 I Beam

8" X 4" X 18.4#	\$51.95 CWT.
-----------------	--------------

Secondary Wide Flange Beam

\$39.90 CWT.

"C" Purlin - Painted

3" X 1 1/2" X 14 GA.	\$.71 FT.
4" X 1 1/2" X 14 GA.	\$.83 FT.
4" X 2" X 14 GA.	\$.92 FT.
6" X 2" X 14 GA.	\$1.12 FT.
8" X 2 1/2" X 14 GA.	\$1.47 FT.
10" X 2 3/4" X 14 GA.	\$1.76 FT.

Available in 20', 25', 30'

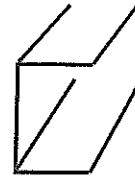

Receiver Channel - Painted

4 3/16" X 2" X 14 GA.(20' + 25')	\$.91 FT.
6 3/16" X 2 1/2" X 14 GA.(20' + 25')	\$1.25 FT.
8 3/16" X 3" X 14 GA.(20' + 25')	\$1.60 FT.

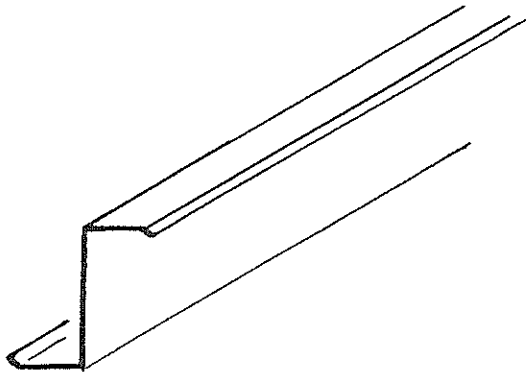

"Z" Purlin Painted

4" X 2 1/2" 14 GA.	\$.92 FT.
8" X 2 1/2" 14 GA.	\$1.47 FT.

available in 21' and 26'

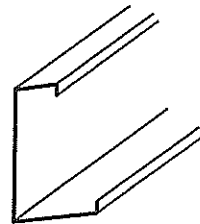

Eave Strut

1:12 Pitch

8" 14 GA. Double Slope 20' & 25' \$2.50 FT.

Purlin Clips

3" X 5" X 10 GA.	\$.61 EA.
5" X 7" X 3/16"	\$1.21 EA.

Structural Steel

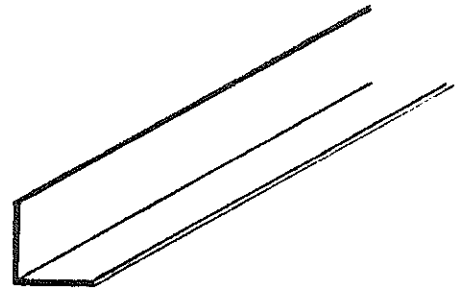
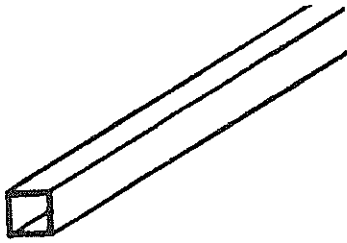

Square Tubing

	Black	Painted
1/2" X 1/2" X 16 GA.	\$.20 FT.	\$.22 FT.
3/4" X 3/4" X 14 GA.	\$.33 FT.	\$.34 FT.
1" X 1" X 14 GA.	\$.45 FT.	\$.47 FT.
1" X 1" X 11 GA.	\$.65 FT.	\$.71 FT.
1 1/4" X 1 1/4" X 14 GA.	\$.57 FT.	\$.60 FT.
1 1/4" X 1 1/4" X 11 GA.	\$.83 FT.	\$.91 FT.
1 1/2" X 1 1/2" X 14 GA.	\$.69 FT.	\$.72 FT.
1 1/2" X 1 1/2" X 11 GA.	\$1.02 FT.	\$1.11 FT.
1 1/2" X 1 1/2" X 3/16"	\$1.49 FT.	
2" X 2" X 14 GA.	\$.93 FT.	\$.98 FT.
2" X 2" X 11 GA.	\$1.38 FT.	\$1.51 FT.
2" X 2" X 3/16"	\$2.05 FT.	\$2.10 FT.
2" X 2" X 1/4"	\$2.52 FT.	
2 1/2" X 2 1/2" X 14 GA.	\$1.17 FT.	
2 1/2" X 2 1/2" X 11 GA.	\$1.75 FT.	
2 1/2" X 2 1/2" X 3/16"	\$2.62 FT.	
3" X 3" X 14 GA.	\$1.42 FT.	\$1.49 FT.
3" X 3" X 11 GA.	\$2.12 FT.	\$2.30 FT.
3" X 3" X 3/16"	\$3.18 FT.	\$3.33 FT.
3" X 3" X 1/4"	\$4.11 FT.	
4" X 4" X 14 GA.	\$1.90 FT.	\$2.00 FT.
4" X 4" X 11 GA.	\$2.86 FT.	\$3.10 FT.
4" X 4" X 3/16"	\$4.31 FT.	\$4.56 FT.
4" X 4" X 1/4"	\$5.69 FT.	
6" X 6" X 3/16"	\$6.87 FT.	\$7.15 FT.
6" X 6" X 1/4"	\$8.98 FT.	\$9.33 FT.

Angle Iron

1/2" X 1/2" X 1/8" X 20'	\$7.57 EA.
3/4" X 3/4" X 1/8" X 20'	\$7.98 EA.
1" X 1" X 1/8" X 20'	\$8.33 EA.
1 1/4" X 1 1/4" X 1/8" X 20'	\$10.52 EA.
1 1/2" X 1 1/2" X 1/8" X 20'	\$12.88 EA.
2" X 2" X 1/8" X 20'	\$16.91 EA.
1" X 1" X 3/16" X 20'	\$11.99 EA.
1 1/2" X 1 1/2" X 3/16" X 20'	\$18.34 EA.
2" X 2" X 3/16" X 20'	\$23.50 EA.
2" X 3" X 3/16" X 20'	\$30.68 EA.
3" X 3" X 3/16" X 20'	\$36.21 EA.
1" X 1" X 1/4" X 20'	\$15.97 EA.
1 1/2" X 1 1/2" X 1/4" X 20'	\$23.05 EA.
2" X 2" X 1/4" X 20'	\$30.08 EA.
2" X 3" X 1/4" X 20'	\$40.68 EA.
3" X 3" X 1/4" X 20'	\$45.22 EA.
3" X 4" X 1/4" X 20'	\$55.96 EA.
4" X 4" X 1/4" X 20'	\$64.05 EA.
4" X 4" X 3/8" X 20'	\$89.98 EA.
6" X 6" X 3/8" X 20'	\$143.54 EA.

Rectangular Tubing

	Black	Painted
2" X 1" X 14 GA.	\$.69 FT.	\$.72 FT.
2" X 1" X 11 GA.	\$1.02 FT.	
3" X 1" X 14 GA.	\$.93 FT.	
3" X 1" X 11 GA.	\$1.38 FT.	
3" X 1 1/2" X 14 GA.	\$1.05 FT.	\$1.10 FT.
3" X 1 1/2" X 11 GA.	\$1.57 FT.	
3" X 2" X 14 GA.	\$1.17 FT.	\$1.23 FT.
3" X 2" X 11 GA.	\$1.75 FT.	
3" X 2" X 3/16"	\$2.62 FT.	
4" X 2" X 14 GA.	\$1.42 FT.	\$1.49 FT.
4" X 2" X 11 GA.	\$2.12 FT.	\$2.30 FT.
4" X 2" X 3/16"	\$3.18 FT.	
6" X 2" X 14 GA.	\$1.90 FT.	\$2.00 FT.
6" X 2" X 11 GA.	\$2.86 FT.	\$3.10 FT.
6" X 2" X 3/16"	\$4.31 FT.	
4" X 6" X 3/16"	\$5.65 FT.	\$5.93 FT.
4" X 8" X 1/4"	\$6.85 FT.	\$7.16 FT.

Rake & Base Angle

Painted - 20' or 25'

4" X 2" X 14 GA.	\$.46 FT.
2" X 2" X 14 GA.	\$.70 FT.

Structural Steel

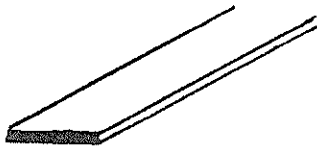

Flat Strap

1/2" X 1/8" X 20'	\$3.32 EA.
1" X 1/8" X 20'	\$5.64 EA.
1 1/2" X 1/8" X 20'	\$7.96 EA.
2" X 1/8" X 20'	\$10.61 EA.
3" X 1/8" X 20'	\$15.91 EA.
4" X 1/8" X 20'	\$21.22 EA.
1" X 3/16" X 20'	\$7.70 EA.
1 1/2" X 3/16" X 20'	\$9.99 EA.
2" X 3/16" X 20'	\$13.32 EA.
3" X 3/16" X 20'	\$19.84 EA.
4" X 3/16" X 20'	\$30.83 EA.
6" X 3/16" X 20'	\$44.75 EA.
2" X 1/4" X 20'	\$17.27 EA.
3" X 1/4" X 20'	\$23.82 EA.
4" X 1/4" X 20'	\$32.94 EA.
6" X 1/4" X 20'	\$47.71 EA.
2" X 3/8" X 20'	\$24.93 EA.
3" X 3/8" X 20'	\$36.69 EA.
4" X 3/8" X 20'	\$46.71 EA.
6" X 3/8" X 20'	\$69.09 EA.
2" X 1/2" X 20'	\$32.75 EA.
4" X 1/2" X 20'	\$62.28 EA.
6" X 1/2" X 10'	\$50.76 EA.
6" X 1/2" X 20'	\$92.12 EA.
8" X 3/4" X 10'	\$102.00 EA.
8" X 3/4" X 20'	\$198.21 EA.

Anchor Bolts

3/4" X 15"	\$3.49 EA.
3/4" X 18"	\$3.95 EA.
3/4" X 21"	\$4.39 EA.

Weld Plates

1/4" X 5" X 8 1/2"	\$2.50 EA.
1/2" X 6" X 7"	\$6.00 EA.
1/2" X 6" X 9"	\$7.50 EA.
1/2" X 6" X 11"	\$9.99 EA.
1/2" X 6" X 13"	\$10.75 EA.
1/2" X 6" X 15"	\$12.50 EA.
1/2" X 6" X 17"	\$14.80 EA.
1/2" X 6" X 19"	\$15.75 EA.

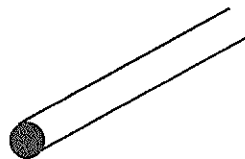

Flat Sheets

4' X 8' X 16 GA.	\$40.95 EA.
4' X 10' X 16 GA.	\$50.95 EA.
4' X 8' X 14 GA.	\$41.95 EA.
4' X 10' X 14 GA.	\$52.95 EA.
4' X 12' X 14 GA.	\$62.95 EA.
5' X 12' X 14 GA.	\$81.95 EA.
4' X 8' X 12 GA.	\$55.95 EA.
4' X 8' X 10 GA.	\$66.95 EA.

Plate Steel

4' X 8' X 3/16"	\$87.50 EA.
4' X 8' X 1/4"	\$116.50 EA.
4' X 8' X 3/8"	\$168.50 EA.
4' X 8' X 1/2"	\$224.50 EA.

Diamond Plate

4' X 8' X 1/8"	\$82.50 EA.
4' X 8' X 3/16"	\$116.95 EA.

Square Bar

1/2" X 1/2" X 20'	\$9.66 EA.
1/2" X 1/2" X 20' Twisted	\$14.50 EA.

Anchor Plates

3/8" Thick, w/4 -1/2" X 5" J Bolts
For use on carports, patios, walk doors
and of endwall columns on small bildings

6" X 6"	\$11.50 EA.
6" X 6"	\$16.00 EA.
6" X 6" X 14" w/4 - 1/2" X 5" Studs	\$9.00 EA.

Roundrod

1/4" X 20'	\$2.87 EA.
3/8" X 20'	\$5.25 EA.
1/2" X 20'	\$7.25 EA.
5/8" X 20'	\$10.61 EA.
3/4" X 20'	\$15.28 EA.

New Reject Sucker Rods

3/4" X 25'	\$12.00 EA.
7/8" X 25'	\$16.00 EA.

Structural Steel



Flattened



Standard

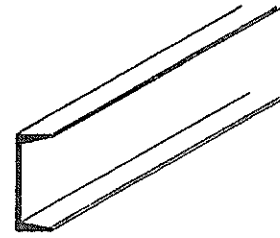

Channel Iron

3" X 4.1#	\$43.16 CWT.
4" X 5.4#	\$43.16 CWT.
5" X 6.7#	\$44.45 CWT.
6" X 8.2#	\$44.45 CWT.
7" X 9.8#	\$48.00 CWT.
8" X 11.5#	\$41.55 CWT.
10" X 15.3#	\$50.76 CWT.

Expanded Metal

4' X 8' Sheets

3/4" X #9 Flat	\$41.95 EA.
3/4" X #9 Std.	\$41.95 EA.
3/4" X #10 Flat	\$35.95 EA.
1 1/2" X #10 Std.	\$27.95 EA.
1/2" X #16 Flat	\$31.95 EA.
#3 Grating	\$72.95 EA.

Bar Channels

1" X 1/2" X 1/8" Bar Channel X 20'	\$12.98 EA.
1 1/4" X 1/2" X 1/8" Bar Channel X 20'	\$15.61 EA.
1 1/2" X 1/2" X 1/8" Bar Channel X 20'	\$15.21 EA.
2" X 1" X 1/8" Bar Channel X 20'	\$21.60 EA.
2" X 1" X 3/16" Bar Channel X 20'	\$31.51 EA.

Rebar

Ungraded

Grade 60

3/8" X 20'	\$11.95 CFT.	3/8" X 20'	\$12.95 CFT.
1/2" X 20'	\$21.95 CFT.	1/2" X 20'	\$22.49 CFT.
5/8" X 20'	\$33.95 CFT.	5/8" X 20'	\$35.49 CFT.

Remesh

5' X 150' X 10 GA.	6" X 6"	\$76.95 EA.
--------------------	---------	-------------

Round Tubing

3/4" O.D. 14 GA. X 24'	\$0.29 FT.
1" O.D. 14 GA. X 24'	\$0.40 FT.
1.66" O.D. 14 GA. X 24'	\$0.60 FT.
1.90" O.D. 14 GA. X 24' & 32'	\$0.70 FT.
2 3/8" O.D. X 10 GA. X 32'	\$1.48 FT.
2 7/8" O.D. X 10 GA. X 32'	\$1.80 FT.

Bar Grating

3' X 20' 1" X 3/16" Bars	\$442.00 EA.
3' X 20' 1 1/4" X 3/16" Bars	\$540.00 EA.

Serrated

Bars on 1 3/16" centers
Cross Bars on 4" centers

Rod Clips

1/4" Rod Clips	\$0.18 EA.
5/16" Rod Clips	\$0.25 EA.

Dome Pipe Caps

2 3/8" Dome Pipe Caps	\$0.99 EA.
2 7/8" Dome Pipe Caps	\$1.12 EA.
3 1/2" Dome Pipe Caps	\$1.23 EA.
4 1/2" Dome Pipe Caps	\$1.73 EA.

16 Ga. Steel Culvert Pipe

12" X 20' & 24'	\$9.25 FT.	12" Band	\$13.50 EA.	Sloped End	\$55.00 EA.
18" X 20' & 24'	\$13.75 FT.	18" Band	\$20.50 EA.	Sloped End	\$125.00 EA.
24" X 20' & 24'	\$18.25 FT.	24" Band	\$27.50 EA.	Sloped End	\$193.00 EA.
36" X 20' & 24'	\$27.75 FT.	36" Band	\$41.50 EA.	Sloped End	\$339.00 EA.

Trim

Ridge Roll

Brown & White \$1.90 FT.
Galvalume + \$1.80 FT.

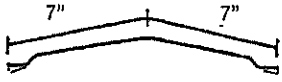

Stk. 10' 3" & 12' 3"

Ridge Flash

Brown & White \$1.90 FT.
Galvalume + \$1.80 FT.



Stk. 10' 3"

Peak Sheet RPN & UPN

White \$9.25 EA.
Galvalume+ \$7.95 EA.

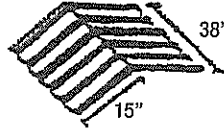

Stk. 2-12 Pitch

Peak Box

Brown & White \$12.00
Galvalume + \$12.00

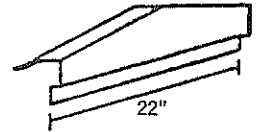

Stk. 1-12, 2-12 & 3-12 Pitch
9" X 7" or Sculptured Profile

Sculptured Rake

Brown & White \$2.40 FT.
Galvalume + \$2.25 FT.

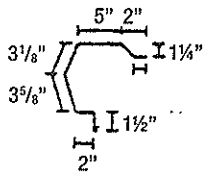

Stk. 10' 3", 12' 3", 14', 16' & 21'

House Rake

RPN
Brown & White \$1.40 FT.
Galvalume + \$1.30 FT.

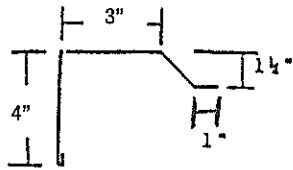

Special Order Only
Stk. 10' 3", 12' 3", 14', 16', 21'

House Rake

UPN
Brown & White \$1.40 FT.
Galvalume + \$1.30 FT.

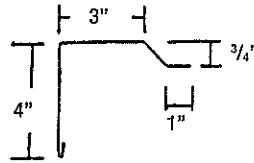

Special Order Only

Sculptured Corner

RPN 6 1/2" X 6 1/2"
Brown & White \$1.90 FT.
Galvalume + \$1.80 FT.

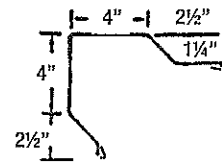

Stk. 10' 3", 12' 3", 14', 16' & 21'

2" X 2" Outside Angle

Brown & White \$.80 FT.
Galvalume + \$.75 FT.

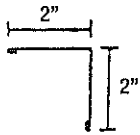

Stk. 10' 3" & 12' 3"

3" X 3" Inside Angle

Brown & White \$.85 FT.
Galvalume + \$.80 FT.

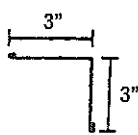

Stk. 10' 3" & 12' 3"

4" X 4" Outside Angle

Brown & White \$1.05 FT.
Galvalume + \$1.00 FT.

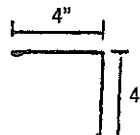

Stk. 10' 3" & 12' 3"

Economy Eave

Brown & White \$.85 FT.
Galvalume + \$.80 FT.

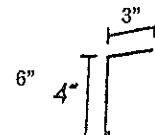

Stk. 10' 3" & 12' 3"

Gutter End Caps (Stk. Brown and White) \$5.00PR. Gutter Strap (Stk. Brown, White or Galvalume) \$.95 EA.

Downspout Sleeves (Stk. Brown or White) \$2.50 EA. Downspout Straps (Stk. Brown or White) \$1.90 EA.

Sculptured Rake End Caps (Special Order Only) \$6.00 PR.



Sweetwater Steel Co. has a large trim shop with multiple pieces of equipment and wide variety of painted coils to meet your needs. Please do not hesitate to call one of our representatives for pricing on a special profile or a special color that you might need.

Trim

Flat Sheets

Brown & White \$.90 SQ. FT.
Galvalume + \$.75 SQ. FT.



Lengths 7' 3", 10' 3",
12' 3" & 14'

Transition RPN

Brown & White \$1.50 FT.
Galvalume + \$1.45 FT.

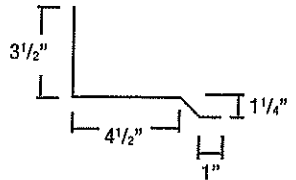

Special Order Only
Stk. 10' 3" - 12' 3"

Transition UPN

Brown & White \$1.50 FT.
Galvalume + \$1.45 FT.

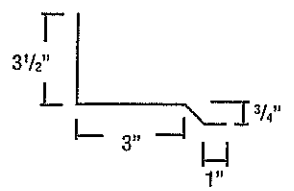

Special Order Only

Die Formed Flashing
10' 5" R or U Panel

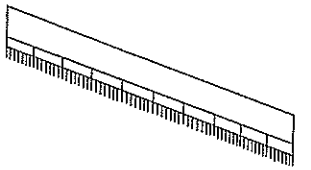

White or Galvalume \$49.90

Door Head & Jamb RPN

Brown & White \$.85 FT
Galvalume + \$.80 FT

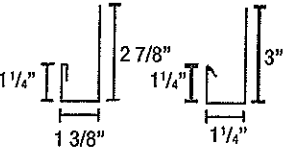

Stk. 7' 3", 10' 3" & 12' 3"

Door Head & Jamb UPN

Brown & White \$.85 FT.
Galvalume + \$.80 FT.

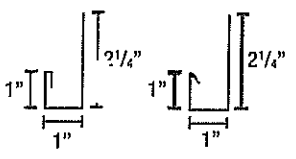

Stk. 7' 3", 10' 3" & 12' 3"

Valley Flashing

Brown & White \$2.80 FT.
Galvalume + \$2.55 FT.

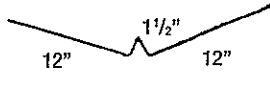

Special Order Only

Galvanized Valley Flashing



50' Rolls
12" \$.89 FT.
18" \$1.38 FT.
24" \$1.75 FT.

Gutter

Brown & White \$2.50 FT.

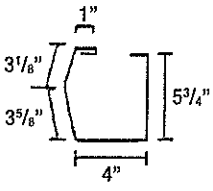

Stk. 10' 3", 12' 3", 14', 16' & 21'

Downspout

Brown & White \$2.75 FT.

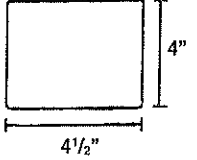

Stk. 10' 3", 12' 3", 14' & 16'

Kickouts

Brown & White
Galvalume + \$12.00 EA.

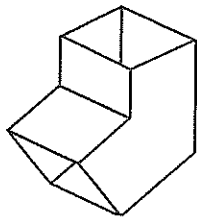

Skylight Stiffeners
White & Galvalume
\$.85 FT.

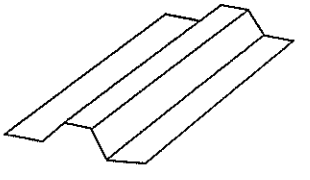

Available
12' 3 only



Ridge Vents
White & Galvalume

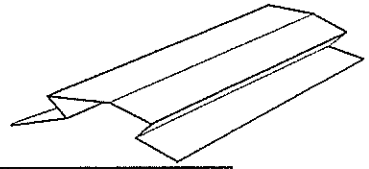

10' Vent with 9" Throat,	Low Profile Splice Kits	\$12.95 EA.
Bird Screen & Damper (White)	20" Round w/Damper	\$198.00 EA.
\$355.00 EA.	3' RPN CobraVent	\$4.95 EA.
Bird Screen & Damper (Galv.)	3' UPN CobraVent	\$4.95 EA.
\$345.00 EA.	1" X 2" X 20' Flex-O-Vent UPN	\$28.95 EA.
Bird Screen & Damper (Color)	1 1/2" X 2" X 20' Flex-O-Vent RPN	\$31.95 EA.
\$399.00 EA.		
10' Low Profile		
\$199.00 EA.		
Low Profile End Caps		
\$15.00 PR.		

Metal Building Accessories

Metal Building Insulation (“R” Factor = 10)

72” X 3” X 103’ (Fiber Reinforced Vinyl) \$233.00 EA.
 Double-Sided Tape \$10.50 EA.
 Fiber Reinforced Patch Tape \$23.00 EA.

R-10.3 Thermal Value

6’ X 125’ X ¼” Radiant Barrier \$299.95 EA.
 Radiant Barrier Patch Tape \$23.00 EA.

Sheetmetal Closures with Adhesive

Inside or Outside “R” Panel \$.69 EA.
 Inside or Outside “U” Panel \$.63 EA.
 25’ X 1½” Foam Sealer \$4.95 EA.
 Beveled Closures RPN (2.8’) \$6.90 PR.
 Beveled Closures UPN (2.83’) \$6.90 PR.
 Expandable Foam Closure RPN (13’ rolls) \$11.50 EA.

Roof Underlayment Hydrashell 50

4’ X 250’ Rolls \$135.00 EA.

Rope Sealer

½” X ¾” X 50’ \$2.75 EA.
 1” X 1½” X 40’ \$4.00 EA.

Nutsetters

¼” \$2.90 EA.
 5/16” \$3.25 EA.
 3/8” \$3.75 EA.

Pop Rivets

Painted
 \$88.00 per 1000
 250 pcs. per bag
 Pop Rivet Gun \$14.95

Drive Pins

¼” X 1½” \$.18 EA.

Self Drill Screws

Plated Painted Longlife

Tekscrews

#12 X ¾”	\$65.00	\$75.00	\$75.00
#12 X 1¼”	\$75.00	\$85.00	\$85.00
#14 X 1”	\$90.00	\$100.00	

Wood Binders

#10 X 1”		\$49.00	\$49.00
#10 X 1½”		\$51.00	\$51.00
#10 X 2½”		\$71.00	\$71.00

Lap Tek

\$75.00 \$85.00 \$85.00

Oversized

#17 X ¾” \$103.00 \$115.00

Pointed

#14 X 1” \$77.50 \$87.50 \$87.50

Tek 4

#12 X 1¼” \$161.00 \$171.00

Phillips Wafer Head

#10 X 1 7/16”	\$80.00
#12 X 2”	\$120.00
#12 X 2½”	\$140.00

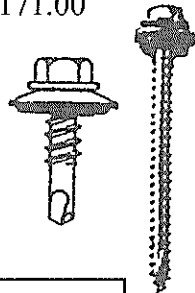

All screws are priced per 1000.

Screws are packaged 250 pieces per bag.

Metal Building Accessories

Doors Are White With Embossed Finish

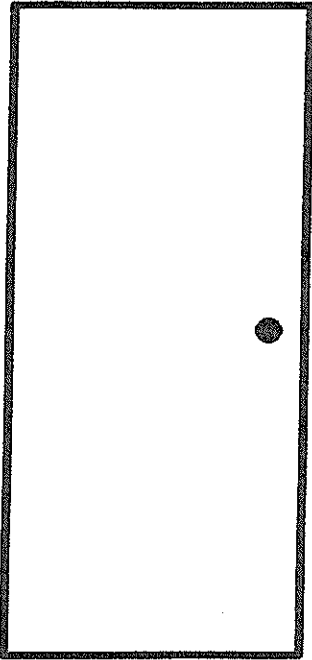

Door Size	Door Price	Frame Size	Frame Price	Complete Door Kit
3' X 7'	\$154.00	8 1/4"	\$109.00	\$320.00
3' X 7'	\$154.00	6 1/4"	\$107.00	\$318.00
3' X 7'	\$154.00	4 1/4"	\$101.00	\$312.00
4' X 7'	\$215.00	8 1/4"	\$116.00	\$393.00
4' X 7'	\$215.00	6 1/4"	\$111.00	\$388.00
4' X 7'	\$215.00	4 1/4"	\$109.00	\$386.00
6' X 7'	\$322.00	8 1/4"	\$126.00	\$545.00
6' X 7'	\$322.00	6 1/4"	\$121.00	\$540.00
6' X 7'	\$322.00	4 1/4"	\$119.00	\$538.00

Kit includes door, frame, grade 2 (heavy duty) lockset, hinges & threshold.

6' X 7' kit includes one 8" surface bolt and 2 3' X 7' doors.

For vertical glass on 3' & 4' doors add \$82.00.

For half glass on 3' & 4' doors add \$82.00 for 3'; \$95.00 for 4'.

Dead Bolt Door add \$20.00 and Dead Bolt Frame add \$20.00.

Thresholds

3'	\$15.00
4'	\$20.00
6'	\$30.00

Panic Hardware with Lever Latch or Ball Knob

\$178.00

Oil Operated Door Closer

\$75.00

8" Surface Bolt for Double Door

\$12.00 EA.

Barrel Hinges

5" \$19.95 Per Pair

7" \$32.95 Per Pair

Screw-On Hinges

4 1/2" X 4 1/2" \$13.00

Per Set of Three

Locksets

Grade 2 (Heavy Duty) \$28.00

Lever Latch \$60.00

Dead Bolt \$45.00

Weld On Hinges

3" X 3" \$2.75

4" X 4" \$4.50

5" X 5" \$9.50



Weatherstrip Kit

3' X 7' \$15.00

4' X 7' \$17.00

Metal Building Accessories

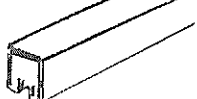
Sliding Door Hardware

8' Small Rail		\$3.00 FT.
10' Small Rail		\$3.00 FT.
12' Small Rail		\$3.00 FT.
20' Small Rail		\$3.00 FT.
Small Rollers		\$15.95 EA.
Small Brackets		\$3.50 EA.
Small Adj. Bracket		\$10.00 EA.
Small Adj. Spl. Bracket		\$13.00 EA.
Small Splice Bracket		\$6.00 EA.
4" Cast Iron V Groove Wheel		\$16.50 EA.

Toggle Clamp 5"	\$6.95 EA.
Toggle Clamp 7"	\$12.95 EA.

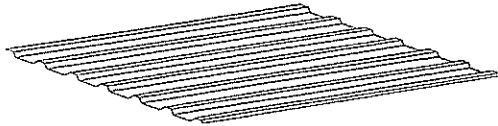

Skylight

"R" Panel 8 OZ. 12'	\$56.00 EA.
"U" Panel 8 OZ. 12'	\$56.00 EA.
Sun Sky Clear or White	
"R" Panel 4 OZ. 12'	\$49.95 EA.
"U" Panel 4 OZ. 12'	\$54.95 EA.
"R" Panel 8 OZ. 11' High Strength Acrylic	\$81.00 EA.
(Acrylic has a 10 year warranty against color change and fiber bloom.)	

Horizontal Sliding Windows with Half Screen

3' X 3'	\$131.25
4' X 3'	\$153.25
6' X 3'	\$164.50

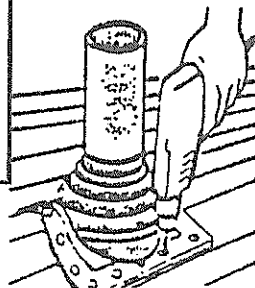
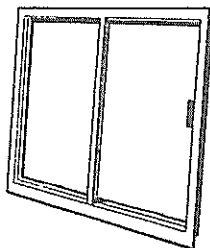

Roll-Up Doors

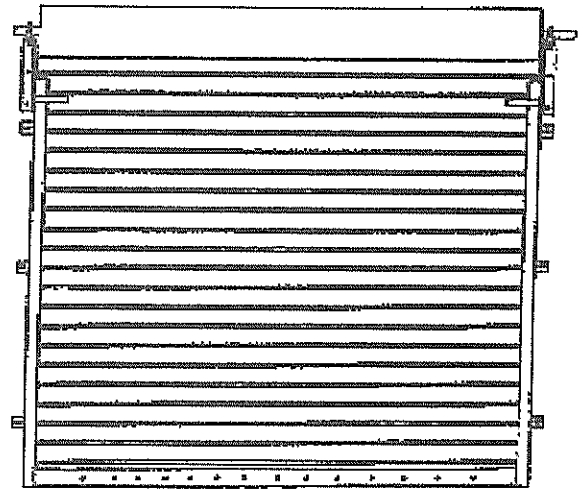

Provene Mini Doors

4' X 7' Mini Door	\$215.00
6' X 7' Mini Door	\$270.00
8' X 8' Mini Door	\$330.00
9' X 7' Mini Door	\$345.00
10' X 8' Mini Door	\$380.00
10' X 10' Mini Door	\$460.00

Porvene Commercial Doors

10' X 10' Commercial Model 211	\$670.00
10' X 12' Commercial Model 211	\$810.00
12' X 10' Commercial Model 211	\$820.00
12' X 12' Commercial Model 211	\$890.00
12' X 14' Commercial Model 211	\$1065.00
14' X 14' Commercial Model 231	\$1485.00
Top Draft Stop	\$2.00 FT.
Electric Door Opener (with Transmitter & Receiver)	\$780.00
Electric Operator Kit	\$99.00
Transmitter	\$45.00

OTHER SIZES AVAILABLE UPON REQUEST

Masterflash

Gray

#3 (1/4" - 4")	\$10.00 EA.
#5 (4" - 7")	\$15.00 EA.
#6 (5" - 9")	\$27.50 EA.
#8 (7" - 13")	\$34.75 EA.
#3 (1/2" X 4") Retro Fit	\$29.00 EA.
Hi Temp Master Flash - Up to 437°	
#6	\$45.00 EA.
#8	\$95.00 EA.

Metal Building Accessories

Kett

Power Sheet KD400	\$199.00 EA.
Shear Blades	\$44.50 EA.
Nibbler Attachments	\$119.00 EA.
Die & Punch	\$79.95 EA.
Punch	\$17.00 EA.

Porter Cable

14" Cut-Off Saw	\$169.00 EA.
4 1/2" Grinder	\$49.95 EA.

Fein

Nibbler	\$799.95 EA.
Die	\$135.00 EA.
Punch	\$19.00 EA.

Welding Rods

50# Box

6011	3/32"	\$93.00 EA.
6011	1/8"	\$95.00 EA.
7018	1/8"	\$98.00 EA.
7018	5/32"	\$100.00 EA.

Brown Oxide Metal Primer

1 Gal.	\$21.50 EA.
5 Gal.	\$96.50 EA.

White Oxide Metal Primer

1 Gal.	\$24.75 EA.
--------	-------------

Ospho Rusted Metal Primer

1 Gal.	\$25.99 EA.
--------	-------------

Touchup Paint

\$9.00 per can

Caulking Sealants

Sono Lastic Clear	\$6.75 EA.
Tite Bond Sealant	\$6.00 EA.
(various colors)	
Caulk Gun	\$5.95 EA.

Hand Tools

1" X 16'	Ratchet & Strap	\$7.50 EA.
2" X 27'	Ratchet & Strap	\$19.95 EA.

Hitachi

14" Cut-off Saw	\$179.00 EA.
14" Cut-off Blade	\$5.00 EA.
Nibbler	\$369.00 EA.
Die	\$18.00 EA.
Punch	\$10.00 EA.
Electric Screw Gun	\$139.00 EA.
4 1/2" Grinder	\$59.95 EA.

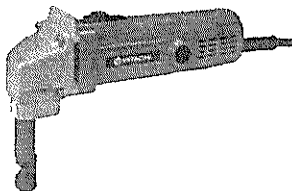

Steelmax

9" Metal Cutting Saw	\$499.95 EA.
9" Metal Cutting Blade	\$48.95 EA.

Other Tools

Tenryu 7 1/4" Saw Blade	\$39.95 EA.
Lotus 4 1/2" Grinding Wheel	\$1.79 EA.
Tin Snips	\$15.95 EA.
Linemans Pliers	\$21.95 EA.

DeWalt

14" Cut-off Saw	\$215.00 EA.
14" Cut-off Blade	\$7.00 EA.
14" Diamond Blade	\$219.00 EA.
Electric Screwgun	\$219.00 EA.
Cordless Drill/Driver	\$139.50 EA.
4 1/2" Grinding Wheel	\$2.99 EA.
4 1/2" Cut-off Wheel	\$1.99 EA.
7" Grinding Wheel	\$5.49 EA.

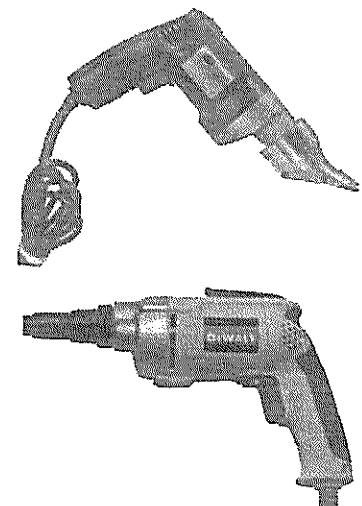
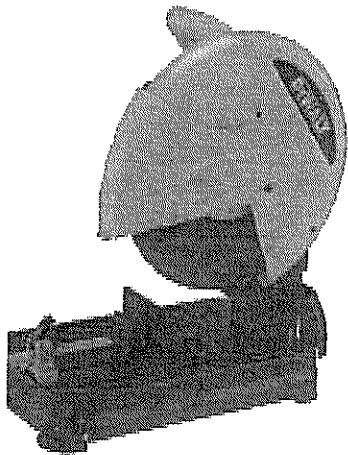

Fence Supplies

V-Mesh Bull Wire

(165' Roll)

I-50	\$411.95 EA.
I-58	\$435.95 EA.
F-58	\$377.00 EA.

Non-Climb Wire

12½ GA. 2" X 4" Spacing

48" X 100'	\$108.95
60" X 100'	\$157.95
72" X 100'	\$210.95

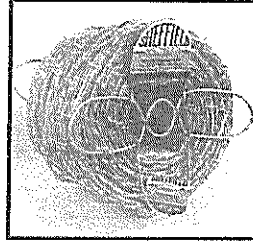

American Barbwire

(¼ Mile Rolls)

12¾ GA. 5" Spacing	\$51.50
12½ GA. 5" Spacing	\$54.95

Premium Grade Sheffield

12½ GA. 2 PT. Flat 5" SP.	\$59.95
12½ GA. 2 PT. Round 4" SP.	\$60.50
12½ GA. Barbless Cable	\$52.95

Stay Tuff Barbwire

15 ½ GA. 4 PT 3" SP, Hi Tensile	\$61.95
---------------------------------	---------

Pre-Cut Pipe Posts

2 3/8" X .190 wall 8' & 11'	\$1.85 FT.
2 7/8" X .217 wall 8' & 11'	\$2.50 FT.

T-Post Driver	\$34.95 EA.
T-Post Puller	\$35.95 EA.

Sleeve Hinges

2 3/8"	\$10.95 FT.
--------	-------------

Splice-It Crimp & Cut Tool	\$49.95 EA.
LBW wire Splices	\$18.50 Per Box

Stay Tuff Multi Tool	\$149.50 EA.
Barbed Wire Sleeves	\$25.00 EA.
Long Sleeves	\$19.00 EA.

Gripple Fence Hardware

Tensioning Tool	\$59.95 EA.
Single Strand T-clip (10 count)	\$9.99 EA.
Single Strand Splice (20 count)	\$19.99 EA.
Barbed Wire T-clip (10 count)	\$14.99 EA.
Barbed Wire Splice (10 count)	\$10.99 EA.

Pipe Guides

2 3/8"	\$16.95 EA.
2 7/8"	\$16.95 EA.
4 1/2"	\$18.95 EA.



Twist Stays

36" 100 EA.	\$30.95
42" 100 EA.	\$35.75
48" 100 EA.	\$39.95

American Field Fence

(330' Rolls)	Sheffield
8-32-6-12½ GA.	\$112.50
8-32-12-12½ GA.	\$90.75
9-39-6-12½ GA.	\$124.95
9-39-12-12½ GA.	\$99.95
10-47-6-12½ GA.	\$134.75
10-47-12-12½ GA.	\$109.50
	Okla.
13-48-4-12 1/2 GA. (4" X 4" spacing)	\$217.95
18-96-6-12 1/2 GA	\$302.95
20-96-6-12 1/2 GA Hi Tensile	\$412.95

#1 American T-Post

	1.25#/ft.	1.33#/ft.
5½' Green	\$4.28 EA.	\$4.54 EA.
6' Green	\$4.61 EA.	\$4.88 EA.
6½' Green	\$4.97 EA.	\$5.27 EA.
7' Green	\$5.34 EA.	\$5.63 EA.
8' Green	\$6.04 EA.	\$6.33 EA.
10'4" Green		\$9.20 EA.
10'4" Galvanized		\$11.12 EA.

Prices are with 5 clips Extra Clips \$.04 EA.

Less .05 on bundles of 200 or more

Livestock Necessities

Portable Panels

5' X 10'	Galvanized	\$55.95 EA.
4' Gate	Galvanized	\$64.95 EA.
5' X 10'	Painted Green	\$44.95 EA.
5' X 10'	Black Reject	\$30.95 EA.

Galvanized Smoothwire

9 GA. X 100 LBS.		\$79.95
12½ GA. X 100 LBS.		\$80.95
14 GA. X 100 LBS.		\$85.95
17 GA. X 10 LBS.	Per Roll	\$15.25

All Other Gauges
Less than 100 LBS. \$1.25 LB.

Round Bale Feeders

Un-skirted	\$128.00
Skirted	\$153.00

Hexagon Net Wire

6' X 300' X 2"	\$113.95
----------------	----------

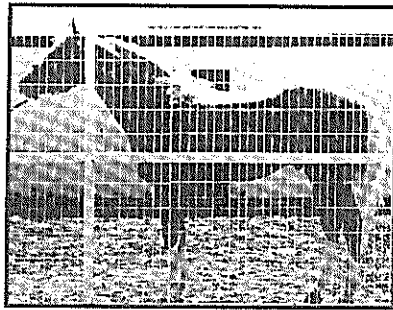
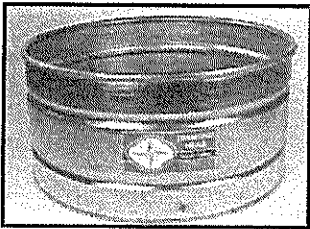

Pasture Gates

8' X 50"	\$79.25
10' X 50"	\$96.50
12' X 50"	\$102.95
14' X 50"	\$116.75
16' X 50"	\$121.50

1½" Galvanized
Tubing Frame
6 GA. 4" X 4" Galv.
Wire Fabric

Gatebolts

10" All Thread Bolt	\$3.40 EA.
6" Lag Screw	\$1.90 EA.

Galvanized Livestock Panels

34" X 16' X 4 GA.	Hog	\$25.95
52" X 16' X 4 GA.	10 Wire	\$24.95
52" X 16' X 4 GA.	Combo	\$32.50
36" X 20' X 6 GA.	4" X 4"	\$29.95
48" X 20' X 6 GA.	4" X 4"	\$38.95
48" X 20' X 4 GA.	4" X 4"	\$51.95
60" X 20' X 6 GA.	4" X 4"	\$48.50
60" X 20' X 4 GA.	4" X 4"	\$64.95
72" X 20' X 6 GA.	4" X 4"	\$57.95
60" X 20' X 6 GA.	2" X 4"	\$72.95
60" X 16' X (Appx.) 5/16" X 6"		\$59.95

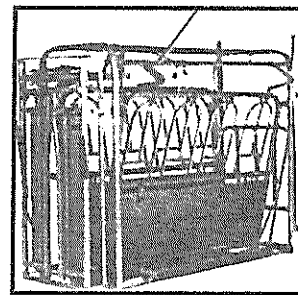

Water Troughs

4' X 2' Round (158 gal.)	\$116.95
6' X 2' Round (394 gal.)	\$183.95
8' X 2' Round (717 gal.)	\$282.95
10' X 2' Round (1135 gal.)	\$408.95
2' X 2' X 4' Oblong (95 gal.)	\$80.95
2' X 2' X 6' Oblong (148 gal.)	\$120.95
2½' X 2' X 8' Oblong (252 gal.)	\$166.95

Filson Cattle Handling Equipment

Automatic Squeeze Chute	\$2395.00
Automatic Headgate	\$695.50
Calf Table	\$1595.00
Wheel Kit for Squeeze Chute	\$630.00

Sweetwater Steel Company
10416 North I-20
Sweetwater, TX 79556

PRESORTED
STANDARD
U.S. POSTAGE
PAID
ABILENE, TX
PERMIT NO. 187

SWEETWATER STEEL

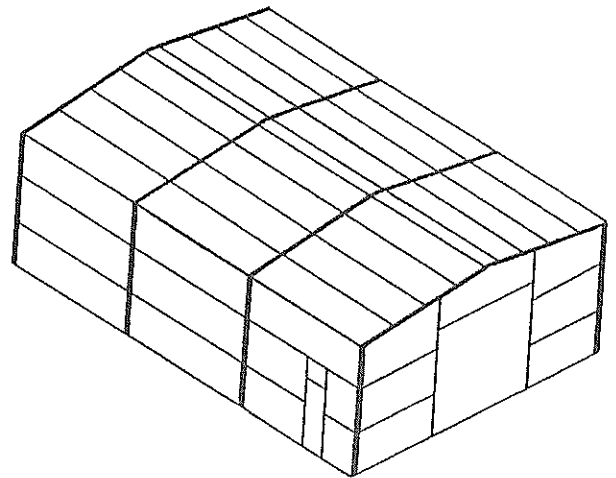
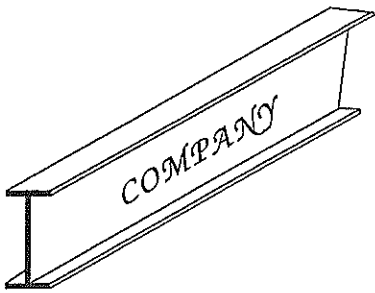

- Metal Building Products
- Structural Steel
- Fencing Supplies

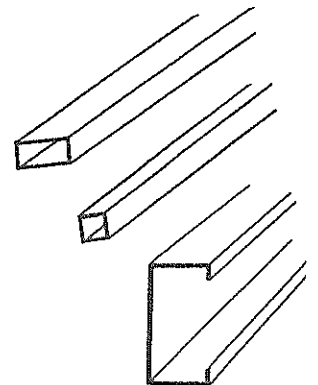

*Two Locations
to Serve Your Needs*

